

PULPDENT®

Dental Innovation Since 1947

ACTIVA™ BioACTIVE

A Closer Look at BioACTIVE Materials

Changes everything you know about Composites,
Glass Ionomers and RMGIs

Fifth Edition



BioACTIVE Products for ProACTIVE Dentistry

Advances in dental materials make possible a proactive approach to patient treatment and oral health care. Bioactive materials that behave favorably in the moist oral environment, help neutralize conditions that cause dental caries, provide prevention benefits, and maximize the potential for remineralization will become the accepted standard of care.

Mimics Nature

ACTIVA BioACTIVE dual cure products are the first dental resins that mimic the physical and chemical properties of teeth. They contain three key components:

- Bioactive ionic resin matrix
- Shock-absorbing rubberized resin component
- Reactive ionomer glass fillers.

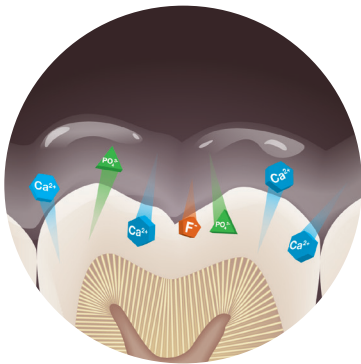

These bioactive products actively participate in the cycles of ionic exchange that regulate the natural chemistry of our teeth and saliva and contribute to the maintenance of tooth structure and oral health.

Strong, Esthetic, BioActive

ACTIVA BioACTIVE has the strength, esthetics and physical properties of composites. It releases significant calcium, phosphate and fluoride, and has a greater ability to recharge these minerals than glass ionomers or RMGIs.

- Esthetic
- Chemically bonds
- Seals teeth against bacterial leakage^{2,3}
- Releases/recharges calcium, phosphate and fluoride
- Provides long-term patient benefits

Stimulates Apatite Formation

ACTIVA BioACTIVE elicits a natural response that stimulates apatite formation and the natural remineralization process that knits together the restoration and tooth and seals margins against microleakage and failure. This is an essential requirement of bioactive materials.

Durable

ACTIVA BioACTIVE is durable and wear resistant.^{27,28} Although the dual cure material contains water, it has extremely low solubility.^{8,20} The ionic resin matrix facilitates the diffusion of calcium, phosphate and fluoride ions while still maintaining the excellent physical properties associated with resins and composites.

Tough, Fracture Resistant

ACTIVA BioACTIVE products contain a rubberized resin component that makes them tougher and more resistant to fracture and chipping than composites.^{4,5,17,29,34}

Toughness, measured by deflection at break, is the ability of a strong, hard material to absorb stress without fracturing.

Deflection at break of ACTIVA BioACTIVE is 2-3 times greater than composites and 5-10 times greater than GIs and RMGIs^{4,5,17}

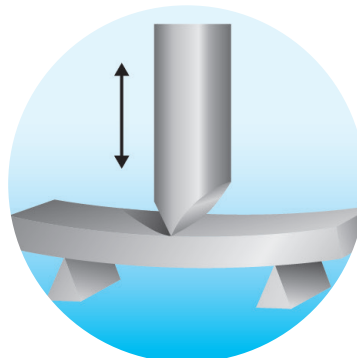

Dynamic “Smart” Material

Unlike traditional materials that are hydrophobic, repel water, and are designed to be passive, ACTIVA BioACTIVE is moisture friendly and plays a dynamic role in the mouth.

Only moisture friendly materials that are partly water-based or have the capacity for significant water transport can react to changes in the ambient conditions and are capable of this dynamic behavior.⁶



ACTIVA BioACTIVE reacts to the continuous pH changes in the oral environment to help fortify and recharge the ionic properties of saliva, teeth and the material itself.^{1,7,9} For this reason, ACTIVA BioACTIVE is considered a “smart” material.

No Bisphenol A

- ACTIVA BioACTIVE products contain no Bisphenol A, no Bis-GMA, no BPA derivatives
- Two-paste, automix systems
- Three setting mechanisms: light cure, self-cure resin chemistry, and self-cure glass ionomer reaction

Bioactive Materials

Bioactive dental materials stimulate apatite formation that fills micro-gaps, seals margins against microleakage, and helps rebuild teeth. Bioactive materials that are strong, esthetic, and long-lasting offer an alternative to traditional composites, which are strong and esthetic but are passive and without bioactive potential, and to glass ionomers, that release a significant amount of fluoride but have poor esthetics and undesirable physical properties.

The development of bioactive materials is inspired by nature, where water is the source of life. In the oral cavity, saliva is the life source and is rich with water, proteins and ionic components.



The oral environment is exposed to continuous pH cycles, and saliva and tooth structure participate in an endless cycle of mineral exchange.

When the pH is low, the demineralization process releases calcium and phosphate ions from the tooth surface. As the pH rises, these ions are available to interact with fluoride ions in our saliva.

Bioactive materials imitate nature and participate in this dynamic ionic exchange. They are water-based or have the capacity for significant water transport or storage and continuously release and recharge their ionic components.⁶

They react to the changes in the oral environment to bring about advantageous changes in the properties of saliva, teeth and the materials themselves. This is often referred to as "smart" behavior.⁶

Saliva is a natural caries protection agent and contains the minerals that maintain the integrity of the enamel surface.

It helps maintain the health of the hard and soft tissues, removes waste, and is the first line of defense against microbial invasion.

Bioactive dental materials help regulate the chemistry of teeth and saliva and contribute to the maintenance of oral health.

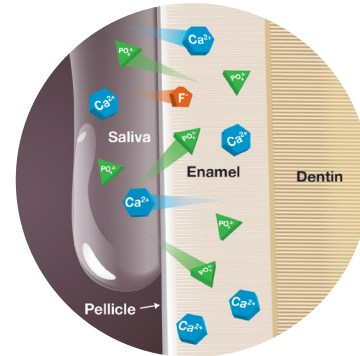

Ionic Resins

ACTIVA BioACTIVE dual cure products are formulated with a patented, ionic-resin (Embrace resin) that contains a small amount of water. It is bioactive, mimics nature, and responds to changes in the oral environment.⁹



The ionic resin is moisture friendly, which is a requirement of bioactive materials. Water placed next to the ionic resin mixes with the resin.

ACTIVA BioACTIVE's ionic resin contains phosphate acid groups that improve the interaction between

the resin and the reactive glass fillers and enhance the interaction with tooth structure.

Through an ionization process that is dependent upon water, hydrogen ions break off from the phosphate groups and are replaced by calcium in tooth structure.

This ionic interaction binds the resin to the minerals in the tooth, forming a strong resin-hydroxyapatite complex and a positive seal against microleakage.^{2,3,14,15,16,19}

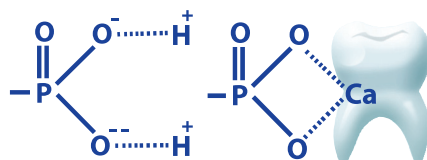

ACTIVA BioACTIVE participates in a dynamic system of ionic exchange with saliva and tooth structure, continuously releasing and recharging calcium, phosphate and fluoride ions and reacting to pH changes in the mouth.^{1,7,9,11}

Unique properties of the ionic resin:

- Significantly releases and recharges with fluoride^{1,7,11}
- Releases a great amount of phosphate¹¹
- Intimate adaptation to tooth structure.^{2,3,10}
- Exceptional marginal integrity^{10,15,16}
- Seals against bacterial leakage^{2,3}



BioACTIVE-RESTORATIVE™

BioACTIVE-CEMENT™

BioACTIVE-BASE/LINER™

ACTIVA™ kids
BioACTIVE-RESTORATIVE™

The US Food & Drug Administration has allowed the claim that ACTIVA BioACTIVE products contain a bioactive resin matrix and bioactive fillers, ushering in a new category of bioactive dental products.

ACTIVA BioACTIVE stimulates apatite formation and the natural remineralization process that knits together the restoration and the tooth and seals margins against microleakage and failure. This is an essential requirement of bioactive materials.

ACTIVA BioACTIVE combines the benefits of composites and glass ionomers while eliminating the disadvantages associated with those materials.

ACTIVA BioACTIVE-BASE/LINER is more bioactive than glass ionomers and RMGIs, and releases and recharges significant calcium, phosphate and fluoride in a strong, resilient resin matrix that will not chip or crumble. The Base/Liner adheres to dentin and does not require etching or bonding agents.

ACTIVA BioACTIVE-RESTORATIVE and **ACTIVA Kids** combine the esthetics, strength and resilience of composites with bioactive properties that are superior to glass ionomers and RMGIs. ^{1,2,3,4,5,17,53}

ACTIVA BioACTIVE-CEMENT is effective with all substrates, and its ability to absorb shock and stress acts like a ligament to resist fracture and chipping.

ACTIVA BioACTIVE products are the first bioactive dental materials with an ionic resin matrix, a shock-absorbing resin component and bioactive fillers that mimic the physical and chemical properties of natural teeth. They are durable, wear and fracture resistant, chemically bond to teeth, seal against bacterial microleakage, and release and recharge calcium, phosphate and more fluoride ions than glass ionomers,^{1,7,11} delivering long-term benefits and better oral health care for your patients.

ACTIVA BioACTIVE contains no Bisphenol A, No Bis-GMA and no BPA derivatives.

3 Key Components

An unparalleled combination of physical and chemical properties delivers bioactivity, toughness, resilience, durability and marginal integrity.

1. Patented bioactive ionic resin
2. Patented rubberized resin
3. Reactive ionomer glass

Key Properties:

- Natural esthetics - Highly polishable
- Tough, resilient – absorbs shock
- Resists fracture, wear, chipping and crumbling
- Releases and recharges calcium, phosphate and fluoride
- Chemically bonds – Seals against bacterial microleakage
- No sensitivity - Moisture tolerant - Simplified technique

Special Features

- Automix syringe with unique precise placement mix tips
- O2 layer integrates with restorative composites
- Ideal for bulk filling
- Light cure and self-cure
- Depth of cure with light: 4mm

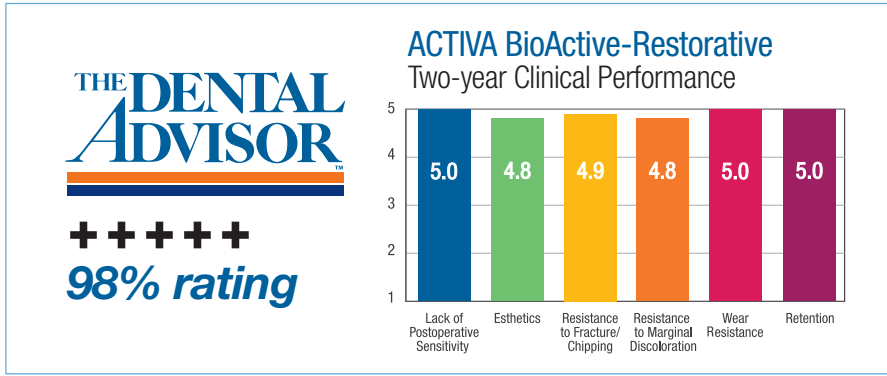

Unique and unprecedented.

– Croll TP, Berg JH, Donly KJ

Outstanding results! – **Dr. Mark Cannon**

Truly impressive – **Dr. Josh Wren**

Totally cool and utterly awesome

– Dr. Ted Croll

ACTIVA BioACTIVE-RESTORATIVE

53-month Recall



1A December 2012
Failing amalgam restoration with mesial marginal ridge fracture.

Courtesy of Dr. John Comisi



1B December 2012
Prepared tooth.



1C December 2012
ACTIVA BioACTIVE-RESTORATIVE post op.



1D May 2017
53-month recall shows great esthetics, no wear or chipping, and no marginal staining.

Replace Failed Composite with ACTIVA BioACTIVE-RESTORATIVE



2A Shows 15-second etch. After rinsing, all excess moisture is removed.

Courtesy of Dr. Mark Cannon



2B ACTIVA BioACTIVE-RESTORATIVE is placed using mixing tip with bendable metal cannula.



2C Explorer is used to create anatomy.

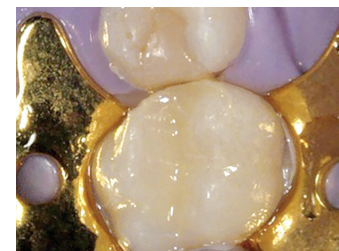

2D Shows finished and polished restoration.

Minimally Invasive Class II



3A Shows minimally invasive tooth preparation.

Courtesy of Dr. Leon Katz



3B After 15-second etch and removal of excess moisture, shows esthetic ACTIVA restoration.

Core Build Up



4A ACTIVA is used to build the core on a badly broken down molar.

Courtesy of Dr. Robert Lowe



4B Tooth is ready to receive a crown.

Repairing Caries Under Crown Margin



5A Caries under crown margin has been removed. 15-second etch and removal of all excess moisture not shown.

Courtesy of Dr. Robert Lowe

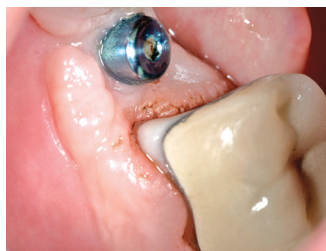

5B Moisture-friendly ACTIVA bonds to tooth, metal and ceramics, and mimics the function of missing tooth structure.

Repairing Sensitive Cervical Lesions



6A Shows cervical lesions of lower bicuspids.

Courtesy of Dr. C.H. Pameijer



6B After etching, bonding agent was applied for added retention. ACTIVA provides esthetics, bioactivity, and patient comfort.

ACTIVA Kids

ACTIVA™ KIDS is easy to place and is an opaque white shade ideally suited for primary teeth.

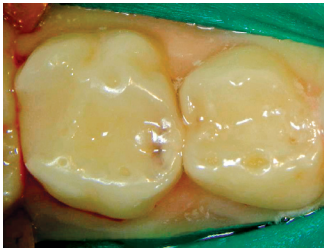

7A Pre-op shows secondary caries on restored molars

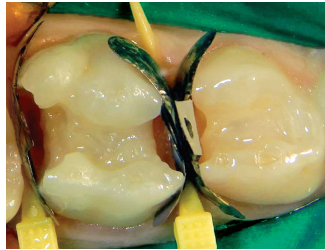

7B Prepared teeth

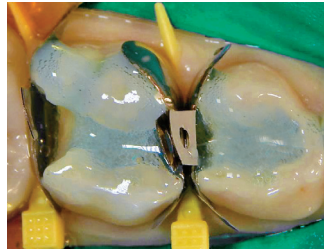

7C Teeth are etched for 15 seconds



7D Shows teeth restored with ACTIVA™ KIDS

Photos courtesy of Dr. Mark Cannon

ACTIVA BioACTIVE-BASE/LINER



8A Shows prepared tooth after removing deep caries under a failed composite restoration.

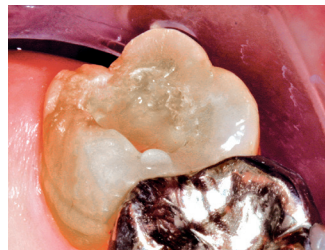

8B Shows ACTIVA BioACTIVE-BASE/LINER placed and cured. No etching required. Note dentin shade match.

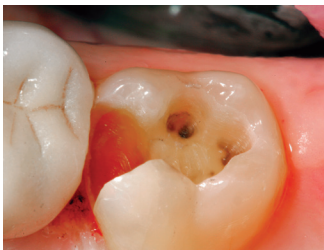

9A Prepared tooth



9B Shows ACTIVA BioACTIVE-BASE/LINER after light curing



9C Etch with Etch-Rite phosphoric acid gel



9D Finish restoration using composite or ACTIVA BioACTIVE-RESTORATIVE

Photos courtesy of Dr. Robert Lowe

ACTIVA BioACTIVE-CEMENT

A simple cementation procedure: self-adhesive, syringe delivery, no trituration, easy clean up



10A Tooth is prepared to receive a crown. Note retentive crown prep.

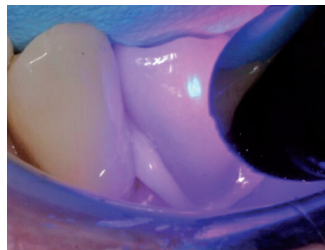

10B Crown filled with ACTIVA BioACTIVE-CEMENT is seated and tack cured 1-2 seconds.



10C Excess cement is easily removed



10D Shows finished case

Photos courtesy of Dr. G. Franklin Shull

Physical Properties

Strength

Compressive and Diametral Tensile Strength of ACTIVA BioACTIVE-RESTORATIVE is comparable to composites and far superior to glass ionomers and RMGIs.

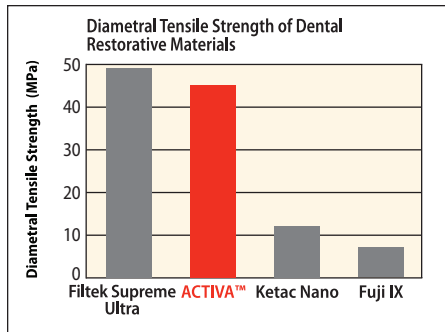
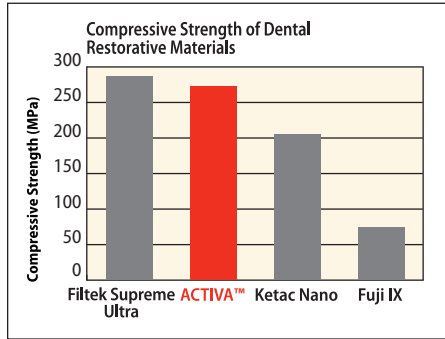

Filtek = Composite; ACTIVA = Bioactive Restorative; Ketac Nano = RMGI; Fuji IX = Glass Ionomer

Source: University testing¹⁷
(see back page for trademark information)

Compressive and Flexural Strength of ACTIVA BioACTIVE-BASE/LINER is much greater than resin-modified base/liners and RMGIs.

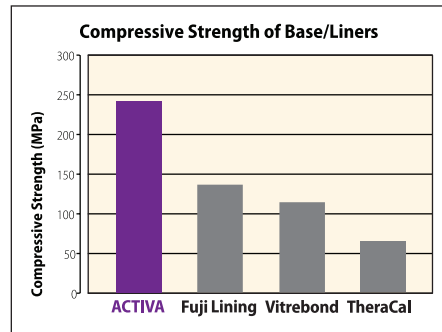
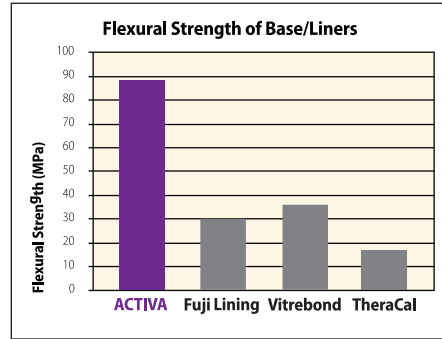

ACTIVA = Bioactive Base/Liner; Fuji Lining = RMGI; Vitrebond = RMGI; TheraCal = Resin-Modified Calcium Silicate

Source: Pulpdent testing¹⁸

Shear bond strength of ACTIVA BioACTIVE-CEMENT compares favorably with leading cements and is superior to RMGI and calcium aluminate-glass ionomer cements tested.

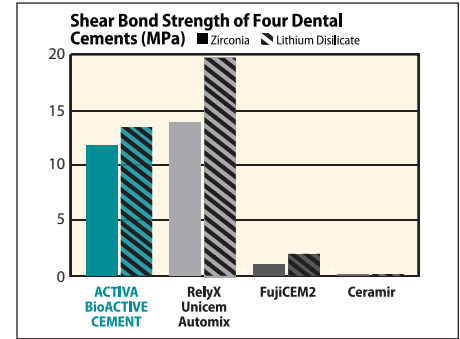

ACTIVA = Bioactive Cement; RelyX = Self-adhesive Cement; FujiCEM 2 = RMGI; Ceramir = Calcium Aluminate-GI

Source: University testing³⁸

Wear

Volume wear of ACTIVA BioACTIVE-RESTORATIVE is comparable to composites and far less than glass ionomer.

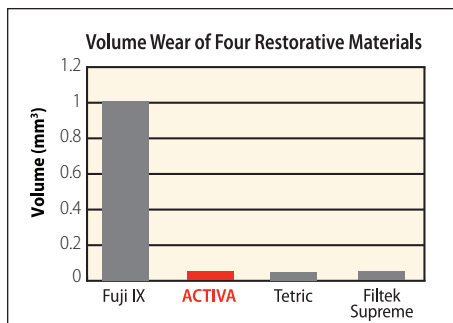

Fuji IX = Glass Ionomer; ACTIVA = Bioactive Restorative; Tetric = Composite; Filtek Supreme = Composite

Source: University testing²⁷
(see back page for trademark information)

When evaluated for surface wear resistance, ACTIVA BioACTIVE-RESTORATIVE performed better than all other materials tested with abrasive

toothpaste and was comparable to flowable composites with non-abrasive toothpaste.

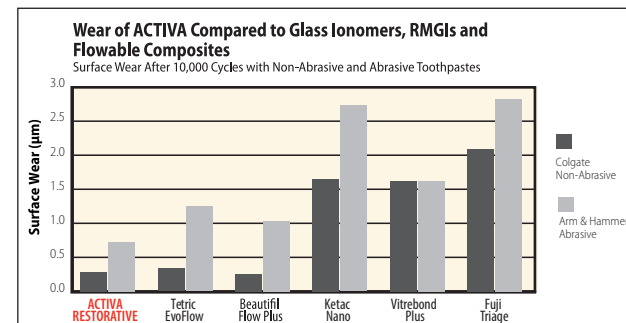

ACTIVA = Bioactive Restorative; Tetric EvoFlow and Beautiful Flow Plus = Flowable Composite; Ketac Nano and Vitrebond Plus = RMGI; Fuji Triage = Glass Ionomer

Source: University testing²⁸

Physical Properties

Toughness, Fatigue Limit, Deflection at Break

ACTIVA BioACTIVE's rubberized resin component provides unparalleled toughness and resilience. Toughness, measured by deflection at break using a 3-point bend test, is the ability of a

strong, hard material to absorb stress, dissipate forces and resist fracture when a load is applied. Fatigue limit is determined by the incremental load required to cause fracture within a defined number of cycles.

Deflection at Break of ACTIVA BioACTIVE is 2-3 times greater than composites and 5-10 times greater than GIs and RMGIs.

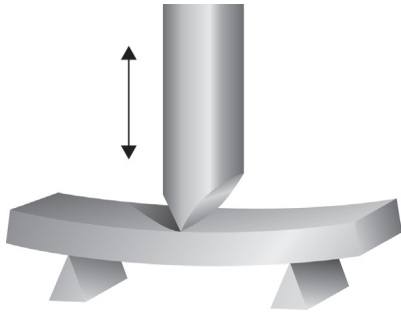
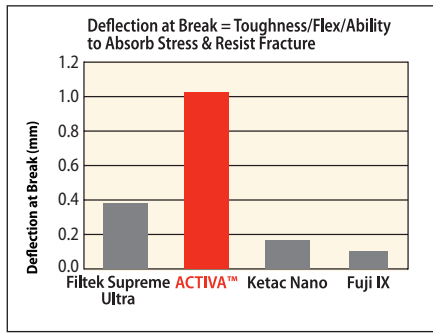
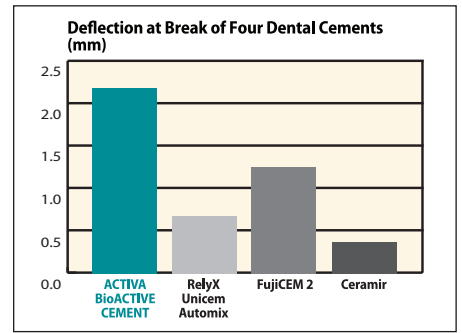

Illustration shows 3-point bend test



Filtek = Composite; ACTIVA = Bioactive Restorative; Ketac Nano = RMGI; Fuji IX = GI

Source: University testing^{5,17}
(see back page for trademark information)



ACTIVA = Bioactive Cement; RelyX Unicem Automix = Self-adhesive Cement; FujiCEM 2 = RMGI; Ceramir = Calcium Aluminate-GI

Source: University testing³⁴

Flexural Strength and Flexural Fatigue

Flexural strength and flexural fatigue measure the amount of stress a material can withstand, measured by deflection at break, and its endurance, measured

by the number of repeated cycles before failure. ACTIVA BioACTIVE meets the requirement of ISO 4049 for occlusal restorations and demonstrates flexural

strength and flexural fatigue comparable to flowable composites (FC) and significantly greater than conventional RMGIs and GIs tested.

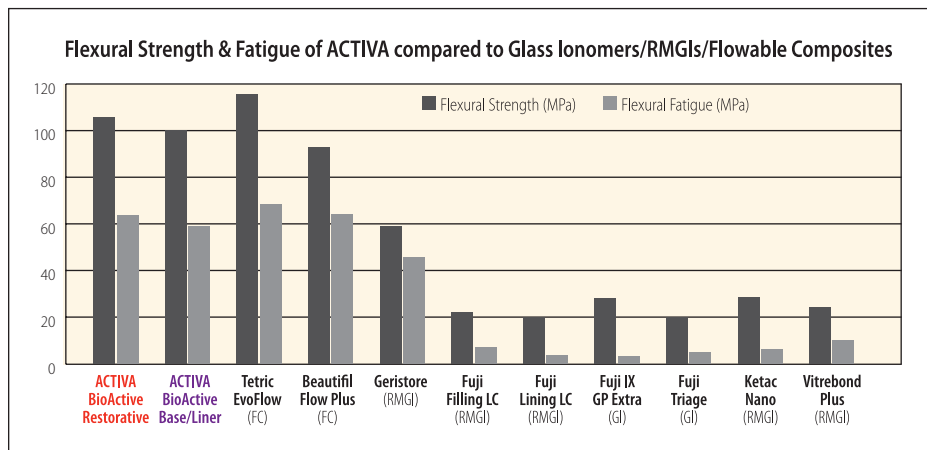

Source: University testing²⁹
(see back page for trademark information)

Physical Properties

Water Absorption

A controlled and relatively low level of water absorption is advantageous for bioactive materials, which require water to unlock their bioactive properties and potential for ionic exchange. Excessive water absorption can compromise the physical properties of restorative and base/liner materials over time.

Water absorption of ACTIVA BioACTIVE-RESTORATIVE is significantly less than glass ionomers and RMGIs, and is designed to be slightly higher than composites, which are hydrophobic and not bioactive.

Water absorption of ACTIVA BioACTIVE-BASE/LINER is far less than RMGIs. Water

absorption of TheraCal is 7 times greater than ACTIVA.

Water absorption of ACTIVA BioACTIVE-CEMENT compares with the leading self-adhesive cement and is far less than the RMGI and calcium aluminate-glass ionomer cements tested.

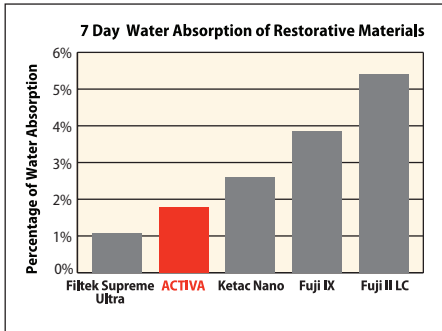

ACTIVA = Bioactive Restorative; Filtek = Composite; Ketac Nano = RMGI, Fuji IX = GI; Fuji II LC = RMGI

Source: Pulpdent testing⁸
(see back page for trademark information)

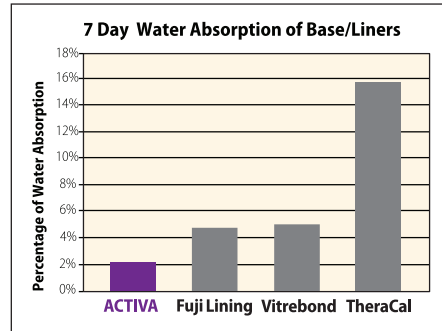

ACTIVA = BioACTIVE Base/Liner; Fuji Lining & Vitrebond = RMGI; TheraCal = Resin-Modified Calcium Silicate

Source: Pulpdent testing²⁰

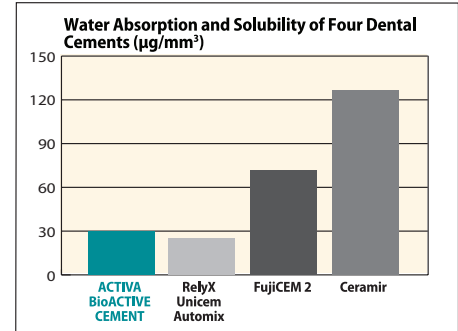

ACTIVA = Bioactive Cement; RelyX Unicem Automix = Self-adhesive Cement; FujiCEM 2 = RMGI; Ceramir = Calcium Aluminate-GI

Source: University testing³⁷

Water Solubility

Low water solubility is important for ensuring the durability and longevity of a dental material. The patented resins and reactive glass fillers in ACTIVA BioACTIVE products are balanced to deliver both bioactivity, which requires water, and durability. This unique combination

of attributes, when combined with esthetics, sets ACTIVA BioACTIVE apart from all other restorative materials.

ACTIVA BioACTIVE has remarkably low water solubility that compares favorably with leading composites and is far lower than glass ionomers and RMGIs.

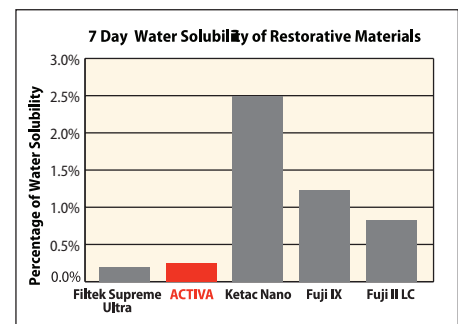

Source: Pulpdent testing²⁰
(see back page for trademark information)

Radiopacity

The radiopacity of ACTIVA BioACTIVE is equivalent to 1.5mm of aluminum.

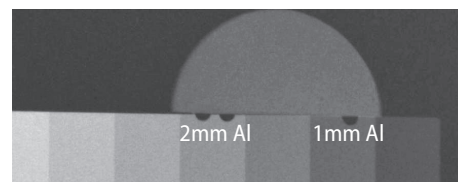

Bioactive Properties

Apatite Formation

Apatite formation is an essential requirement of bioactive materials. ACTIVA BioACTIVE stimulates mineral apatite formation and the natural remineralization process that knits together the

restoration and the tooth together and seals margins against microleakage and failure.

ACTIVA BioACTIVE responds to pH cycles and plays an active role in maintaining oral

health with release and recharge of significant amounts of calcium, phosphate and fluoride. These mineral components stimulate formation of a protective/connective apatite layer and a natural bonded-seal at the material-tooth interface.

SEM Analysis of ACTIVA BioACTIVE-CEMENT after 21 Days in Saline

Compared to the no saline control, scanning electron microscope (SEM) imaging and energy-dispersive X-ray spectroscopy (EDS) after 21 days in saline shows significant increase in calcium and phosphorus ion concentrations, and decrease in carbon and silica ions, indicating that mineral apatite deposits are forming on the surface.

Source: University testing³⁵

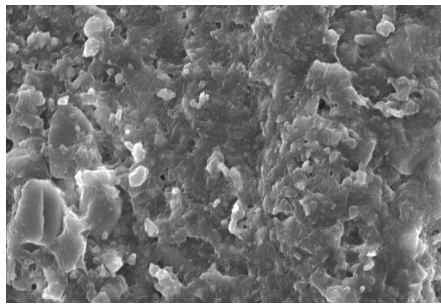

ACTIVA BioACTIVE-CEMENT Control, no saline 3000x

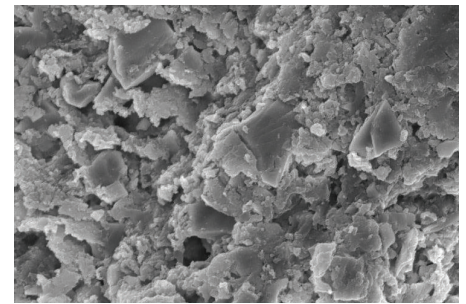

ACTIVA BioACTIVE-CEMENT 21 days in saline 3000x

SEM and EDS Analysis Verifies Bioactive Component

Scanning electron microscope (SEM) imaging and energy-dispersive X-ray spectroscopy (EDS) analysis of dentin discs treated with ACTIVA BioACTIVE-CEMENT and placed in phosphate buffered solution verifies the bioactive

Source: University testing⁴¹

component of the material and demonstrates excellent dentinal tubule penetration. A layer of apatite formed and fused the dentin to ACTIVA BioACTIVE. (The gap was produced when the specimen was fractured to make the SEM.)

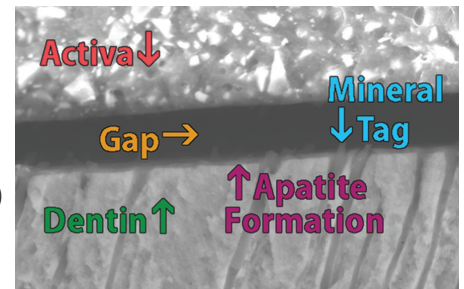

Fluoride Release and Recharge

ACTIVA BioACTIVE releases and recharges fluoride, providing long-term patient benefits for improved oral health care.

University testing using fluoride ion concentration gradient diffusion methodology shows the pattern of release and recharge of ACTIVA BioACTIVE, Ketac Nano and Triage. The study concludes that "at the seven time points tested, the new bioactive material [ACTIVA] has statistically greater fluoride release after recharge at 24 hours, 1 week and 3 weeks than the other groups tested."¹

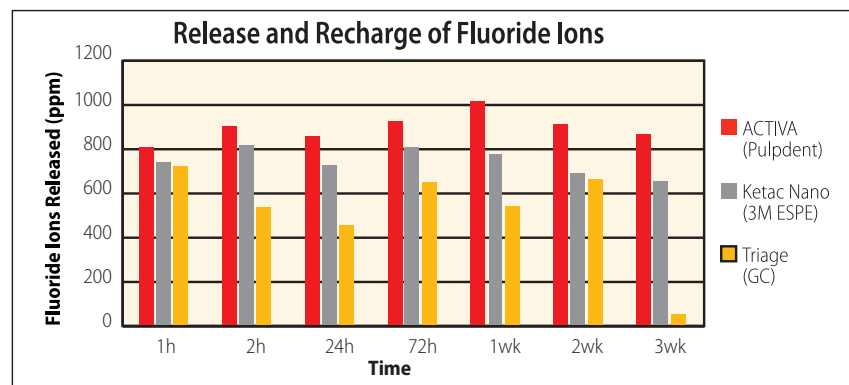

Source: University testing¹ (see back page for trademark information)

Bioactive Properties

Phosphate Release

ACTIVA BioACTIVE is a “smart” material that responds to pH cycles in the mouth. During low pH demineralization cycles, ACTIVA BioACTIVE releases more phosphate. The phosphate ions can reside in the pellicle layer or saliva and are available to interact with calcium and fluoride ions during higher pH cycles.

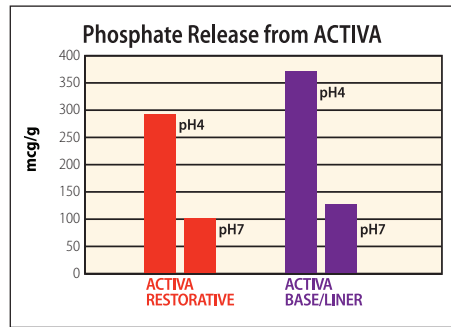

Source: Pulpdent testing⁹

Microleakage

ACTIVA BioACTIVE-RESTORATIVE, when tested in vitro for microleakage *without a bonding agent*, compares favorably with leading composites tested *with a bonding agent* (Scotchbond Universal Adhesive, 3M ESPE).

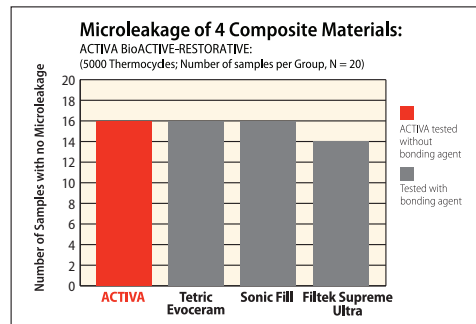

Source: University testing¹⁶ (see back page for trademark information)

Bacterial Microleakage

ACTIVA BioACTIVE-RESTORATIVE outperforms a leading RMGI when tested for bacterial microleakage in vitro after 2,000 thermocycles.

ACTIVA BioACTIVE-BASE/LINER compares favorably with a leading resin modified glass ionomer material when tested for bacterial microleakage in vitro after 2,000 thermocycles.

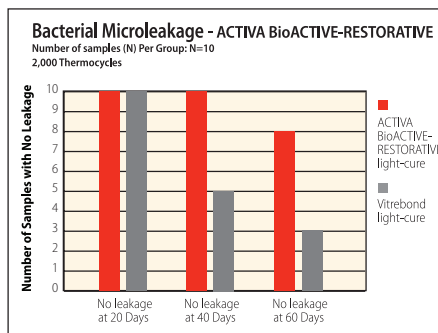

Source: University testing³ (see back page for trademark information)

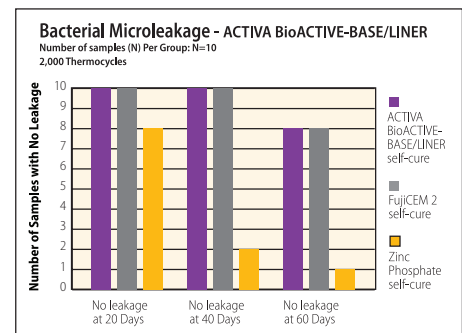

Source: University testing²

References

1. Fluoride ion release and recharge over time in three restoratives. Slowikowski L, et al. *J Dent Res* 93 (Spec Iss A): 268, 2014 (www.iadr.org).
2. Zmener O, Pameijer CH, Hernandez S. Resistance against bacterial leakage of four luting agents used for cementation of complete cast crowns. *Am J Dent* 2014;27(1):51-55.
3. Zmener O, Pameijer CH, et al. Marginal bacterial leakage in class I cavities filled with a new resin-modified glass ionomer restorative material. 2013.
4. Flexural strength and fatigue of new Activa RMGIs. Garcia-Godoy F, et al. *J Dent Res* 93 (Spec Iss A): 254, 2014 (www.iadr.org).
5. Deflection at break of restorative materials. Chao W, et al. *J Dent Res* 94 (Spec Iss A) 2375, 2015 (www.iadr.org).
6. McCabe JF, et al. Smart materials in dentistry. *Aust Dent J* 2011;56 Suppl 1:3-10.
7. Cannon M, et al. Pilot study to measure fluoride ion penetration of hydrophilic sealant. *J Dent Res* 89 (Spec Iss A): 1345, 2010 (www.iadr.org).
8. Water absorption properties of four resin-modified glass ionomer base/liner materials. (Pulpdent)
9. pH dependence on the phosphate release of Activa ionic materials. (Pulpdent)
10. Kane B, et al. Sealant adaptation and penetration into occlusal fissures. *Am J Dent* 2009;22(2):89-91.
11. Rusin RP, et al. Ion release from a new protective coating. *J Dent Res* 88 (Spec Iss A): 3200, 2009 (www.iadr.org).
12. Sharma S, Kugel G, et al. Comparison of antimicrobial properties of sealants and amalgam. IADR Annual Meeting 2008.
13. Naorungroj S, et al. Antibacterial surface properties of fluoride-containing resin-based sealants. *J Dent* 2010.
14. Prabhakar AR, et al. Comparative evaluation of the length of resin tags, viscosity and microleakage of pit and fissure sealants – an in vitro scanning electron microscope study. *Contemp Clin Dent* 2011;2(4):324-30.
15. Pameijer CH. Microleakage of four experimental resin modified glass ionomer restorative materials. April 2011.
16. Microleakage of dental bulk fill, conventional and self-adhesive composites. Cannavo M, et al. *J Dent Res* 93 (Spec Iss A): 847, 2014 (www.iadr.org).
17. Comparison of mechanical properties of dental restorative material. Girn V, et al. *J Dent Res* 93 (Spec Iss A): 1163, 2014 (www.iadr.org).
18. Mechanical properties of four photo-polymerizable resin-modified base/liner materials. (Pulpdent)
19. Singla R, et al. Comparative evaluation of traditional and self-priming hydrophilic resin. *J Conserv Dent* 2012;15(3):233-6.
20. Water absorption and solubility of restorative materials. (Pulpdent)
21. Increasing the service life of dental resin composites. www.nidcr.nih.gov. grants & funding. concept clearances. May 2009.
22. Spencer P, et al. Adhesive dentin interface: the weak link in the composite restoration. *Ann Biomed Eng* 2010;38(6):1989-2003.
23. Murray PE, et al. Analysis of pulpal reactions to restorative procedures, materials, pulp capping, and future therapies. *Crit Rev Oral Biol Med* 2002;13:509.
24. DeRouen TA, et al. Neurobehavioral effects of dental amalgam in children: a randomized clinical trial. *JAMA* 2006;295(15):1784-1792.
25. Nordbo H, et al. Saucer-shaped cavity preparations for posterior approximal resin composite restorations observations up to 10 years. *Quintessence Int* 1998;29(1):5-11.
26. Skartveit L, et al. In vivo fluoride uptake in enamel and dentin from fluoride-containing materials. *J Dent Child* 1990; 57(2):97-100.
27. Wear of a calcium, phosphate and fluoride releasing restorative material. Bansal R, et al. *J Dent Res* 94 (Spec Iss A): 3797, 2015 (www.iadr.org).
28. Wear resistance of new ACTIVA compared to other restorative materials. Garcia-Godoy F, Morrow BR. *J Dent Res* 94 (Spec Iss A): 3522, 2015 (www.iadr.org).
29. Pameijer CH, Garcia-Godoy F, Morrow BR, Jefferies SR. Flexural strength and flexural fatigue properties of resin-modified glass ionomers. *J Clin Dent* 2015;26(1):23-27.
30. Pameijer CH, Zmener O, Kokubu G, Grana D. Biocompatibility of four experimental formulations in subcutaneous connective tissue of rats. 2011.
31. Pameijer CH, Zmener O. Histopathological evaluation of an RMGI ionic-cement [Pulpdent Activa], auto and light cured – A subhuman primate study. 2011.
32. ACTIVA BioActive-Restorative: 6-month clinical performance. The Dental Advisor 2015. www.dentaladvisor.com.
33. ACTIVA BioActive-Restorative: One-year clinical performance +++++. The Dental Advisor 2015. www.dentaladvisor.com.
34. Compressive strength and deflection at break of four cements. Daddona J, Pagni S, Kugel G. *J Dent Res* 95 (Spec Iss A): 0658, 2016 (www.iadr.org).
35. Surface deposition analysis of bioactive restorative material and cement. Chao W, Perry R, Kugel G. *J Dent Res* 95 (Spec Iss A): S1313, 2016 (www.iadr.org).
36. Comparison of compressive strength of liner materials. Epstein N, et al. *J Dent Res* 95 (Spec Iss A): S0653, 2016 (www.iadr.org).
37. Water absorption and solubility of four dental cements. Hall J, et al. *J Dent Res* 95 (Spec Iss A): S1126, 2016 (www.iadr.org).
38. Shear bond strength of several dental cements. Tran A, et al. *J Dent Res* 95 (Spec Iss A): S0579, 2016 (www.iadr.org).
39. Repetitive deflection strengths of adhesive cements. Samaha S, et al. *J Dent Res* 95 (Spec Iss A): S1076, 2016 (www.iadr.org).
40. Fluoride release of bioactive restoratives with bonding agents. Murali S, et al. *J Dent Res* 95 (Spec Iss A): S0368, 2016 (www.iadr.org).
41. Profilometry bioactive dental materials analysis and evaluation of dentin integration. Garcia-Godoy F, Morrow BR. *J Dent Res* 95 (Spec Iss A): 1828, 2016 (www.iadr.org).
42. Staining and whitening products induce color changes of multiple composites. Parks H, Morrow BR, Garcia-Godoy F. *J Dent Res* 95 (Spec Iss A): S1323, 2016 (www.iadr.org).
43. Profilometry based composite abrasion using different current dentifrices. Lindsay AA, Morrow BR, Garcia-Godoy F. *J Dent Res* 95 (Spec Iss A): S0318, 2016 (www.iadr.org).
44. Bansal R, Burgess JO, Lawson NC. Wear of an enhanced resin-modified glass-ionomer restorative material. *Am J Dent* 2016;29(3):171-174.
45. Evaluation of pH, fluoride and calcium release for dental materials. Morrow BR, Brown J, Stewart CW, Garcia-Godoy F. *J Dent Res* 96 (Spec Iss A): 1359, 2017 (www.iadr.org).
46. Adhesion of s. mutans biofilms on potentially antimicrobial dental composites. Mah J, Merritt J, Ferracane J. *J Dent Res* 96 (Spec Iss A): 2560, 2017 (www.iadr.org).
47. Microleakage under class II restorations restored with bulk-fill materials. Kulkarni P, et al. *J Dent Res* 96 (Spec Iss A): 2604, 2017 (www.iadr.org).
48. Fluoride release of dental restoratives when brushed with fluoridated toothpaste. Epstein N, Roomian T, Perry R. *J Dent Res* 96 (Spec Iss A): 1254, 2017 (www.iadr.org).
49. ACTIVA BioActive-Restorative: Two-year clinical performance +++++. The Dental Advisor 2017. www.dentaladvisor.com.
50. May E, Donly KJ. Fluoride release and re-release from a bioactive restorative material. *Am J Dent* 2017;30(6):305-308.
51. Garoushi S, Vallittu PK, Lassila L. Characterization of fluoride releasing restorative dental materials. *Dent Mater J* 2018;37(2):293-300.
52. Reznik J, Kulkarni P, Shah S, Chang B, Burgess JO, Robles A, Lawson NC. Crown Retention Strength and Ion Release of Bioactive Cements. *J Dent Res* 97 (Spec Iss A) 656, 2018 (www.iadr.org).
53. Boutsiouki C, Lucker S, Domann E, Krämer N. Is a bioactive composite able to inhibit secondary caries. Justus-Liebig-Universität Giessen, Vaterstetten. Germany 2017.
54. Alrahlah A. Diametral tensile strength, flexural strength, and surface microhardness of bioactive bulk fill restorative. *J Contemp Dent Practice* 2018;19(1):13-19.
55. Influence of novel bioactive materials on dental enzymatic activity. Comba A, Breschi L, et al. *J Dent Res* 97 (Spec Iss A) 0273, 2018 (www.iadr.org).
56. Dentifrices, surface roughness and depth loss of restorative materials. Smith JB, Lambert AN, Morrow BR, Pameijer CH, Garcia-Godoy F. *J Dent Res* 97 (Spec Iss A) 1621, 2018 (www.iadr.org).
57. Enamel demineralization adjacent to orthodontic brackets bonded with Active Bioactive Restorative. Saunders KG, Donley KJ, Mattevi G. U. of Texas Health Science Center, San Antonio 2017.
58. Bioactive materials, demineralization, and shear strength of orthodontic brackets. Donohue J, et al. *J Dent Res* 96 (Spec Iss A) 3289, 2017 (www.iadr.org).
59. Roulet J-F, et al. In vitro wear of two bioactive composites and a glass ionomer cement. *DZZ International* 2019;1(1):24-30.
60. Banon R, et al. Clinical evaluation of a new bioactive ionic resin material (ACTIVA™ BIOACTIVE) in primary molars - a split mouth randomized trial. Ghent University 2018.
61. Omid BR, et al. Microleakage of an enhanced resin-modified glass ionomer restorative material in primary molars. *Researchgate* 2018;15(4):205-213.
62. Croll TP, Lawson NC. Activa BioActive-Restorative material in children and teens: examples and 46-month observations. *Inside Dentistry* 2018.
63. Sauro S, et al. Effects of ions-releasing restorative materials on the dentine bonding longevity of modern universal adhesives after load-cycle and artificial saliva aging. *Materials* 2019;12:722.
64. Lloyd VJ, Hunter F, Comisi J. The bio-mineralization potential of various bioactive restorative materials, MUSC 2019.
65. Bhradrad, et al. A 1-year comparative evaluation of clinical performance of nanohybrid composite with Activa bioactive composite in Class II carious lesion: randomized control study. *JCD* 2019;22(1):92-96.
66. Maciak M. Novel applications of a bioactive resin in perforations, root resorption and endodontic-periodontic lesions. *Roots* 2018;14(4):32-36.
67. ElReash A, et al. Biocompatibility of new bioactive resin composite versus calcium silicate cements - an animal study. *BMC Oral Health* 2019;19:194-203.
68. Alkhdhairi F, et al. Adhesive bond integrity of dentin conditioned by photobiomodulation and bonded to bioactive restorative material. *Photodyagn Photodyn* 2019;28:110-113.

Related Literature

- Cannon ML, Comisi JC. Bioactive and therapeutic preventive approach to dental pit and fissure sealants. *Compendium* 2013;34(8):642-645.
- Comisi JC. Bioactive materials support proactive dental care. *Cosmetic Dent* 2012;1:7-13
- Delaviz Y, Finer Y, Santerre JP. Biodegradation of resin composites and adhesives by oral bacteria and saliva: a rationale for new material designs that consider the clinical environment and treatment challenges. *Dent Mat* 2014;30(1):16-32.
- Goldstep F. Proactive intervention dentistry: a model for oral care through life. *Compend Contin Educ Dent* 2012;33(6):398-402.
- Niu L, Pashley DH, Breschi L, Tay FR, et al. Biomimetic remineralization of dentin. *Dent Mat* 2014;30(1):77-96.
- Pameijer CH. Report on the retention of Embrace WetBond cement and a RMGI cement (Pulpdent). August 2012.
- Pashley DH, et al. State of the art etch-and-rinse adhesives. *Dent Mater* 2011;27(1):10.
- Peumans M, et al. Clinical effectiveness of contemporary adhesives: a systematic review of current clinical trials. *Dent Mat* 2005;21:864-881.
- Spenser P, et al. Interfacial chemistry of moisture-aged class II composite restorations. *J Biomed Mater Res* 2006;77(2):234-240.
- Wang Z, et al. Dentin biomineralization induced by innovative calcium phosphate/silicate materials. *IADR* 2013.
- Watson TF, et al. Present and future glass ionomers and calcium-silicate cements as bioactive materials in dentistry; biophotonics-based interfacial analyses in health and disease. *Dent Mat* 2014;30(1):50-61.
- www.nidcr.nih.gov
- Yang B, et al. Remineralization of natural dentin caries with one experimental composite resin. *J Dent Res* 88 (Spec Iss A) 2974, 2009 (www.iadr.org)

Trademark Information

Filtek, Ketac, RelyX, and Vitrebond are trademarks of 3M ESPE; Fuji IX, Fuji II LC, Fuji Lining, FujiCEM and Fuji Triage are trademarks of GC; Tetric EvoCeram and EvoFlow are trademarks of Ivoclar Vivadent; SonicFill, TheraCal, Beautiful, and Ceramir are trademarks of Kerr, Bisco, Shofu, and Doxa respectively.

PULPDENT®

© 2019 PULPDENT Corporation. All rights reserved.